

## Welcome to Farma's world



## 1975: Farma is established

Farma is established as a producer for fuel tank caps for after-market, mounting a revolutionary venting device, preventing air pollution caused by fuel vapours.



## 1987: Farma take over Faab co.

Starting the 80's Farma begin to supply OEs, namely FIAT AGRIFUL, RENAULT Italy, etc. mainly thanks to venting device mounted in the caps, conform to EEC norm 70/221 gone into force in EU 1975. As further market consolidation Farma take over their main competitor, Faab co.

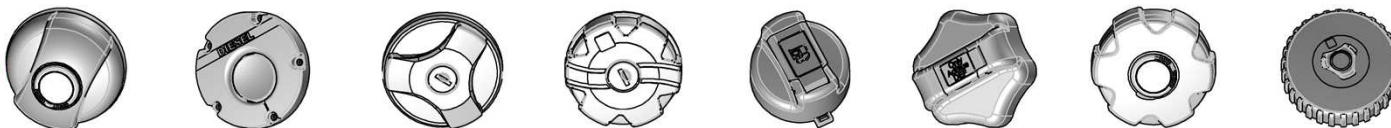

## 1992: foundry

Farma take over the Zamasystem foundry in order to produce by itself the zamak components of the caps.

Today the foundry transforms over **1,600 tons of zamak alloy** into more than **25 million items** a year destined to customers from different market sectors (construction, hydraulic, window frames, food, clothing, furniture, electronic, etc...)

Our **15 latest generation hot-chamber presses** have a closing force ranging from 13 up to 280 tons, for the production of items from 1gr to 1500grs.

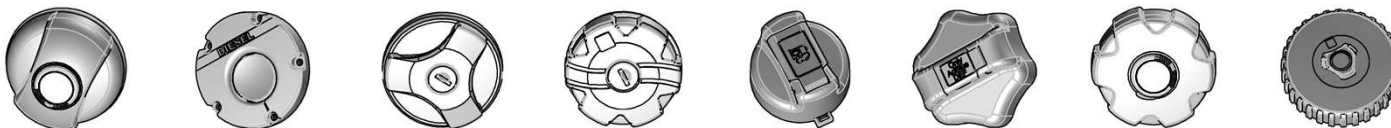

## 1998: mould design office and tooling department

A tooling department and mould design office are created to enhance the technical service and develop any new project or request.

Our Tooling Department counts different machines as

- 3 working centers,
- plunge electro-erosion,
- wire electro-erosion,
- laser welding machine,
- numerically controlled lathe

used for the creation of new equipment and for the constant maintenance of the moulds in use, in order to guarantee the best performances.

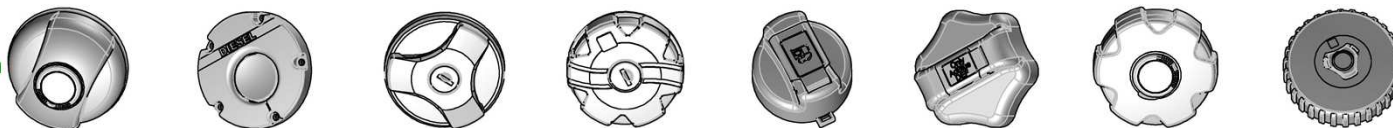
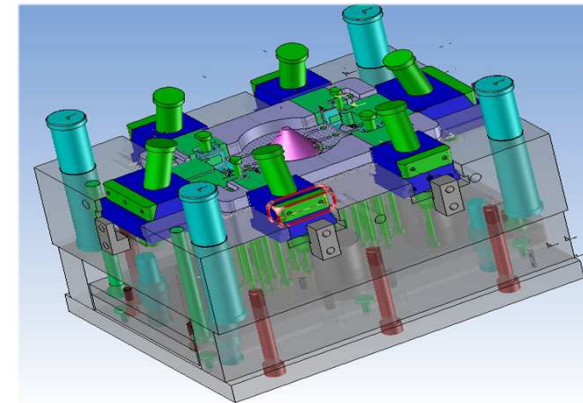

## 2004: Urea business

Farma begin to produce filler necks and caps for Urea tanks, to comply with EURO IV vehicles.

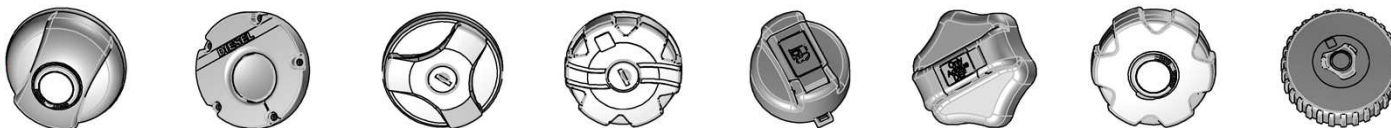

## 2014: plastic division

Farma establish a **modern injection moulding department** allowing to grant top quality material employed in the caps. The Division counts 7 Victory Engel presses responding to the new **Industry 4.0 model**.

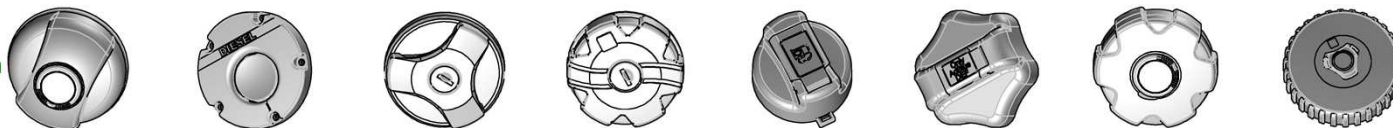

## Farma today

Today Farma is a tank locking set specialist able to offer customized and cutting edge technical solutions to satisfy any customers' needs.



91  
employees



3 buildings  
8,500 sm



1.650.000  
locking sets  
sold in  
2018



15.355.000 €  
2018  
Turnover

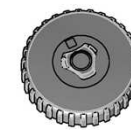

## Results achieved

Since 2018 Farma has obtained the **A+ rating** from CDRITALIA (Moody's certifying body) thanks to its consolidated financial situation and continuous growth, which in recent years has seen an important turnover increase, that is +23.5% in 2017 and +6.2% in 2018.

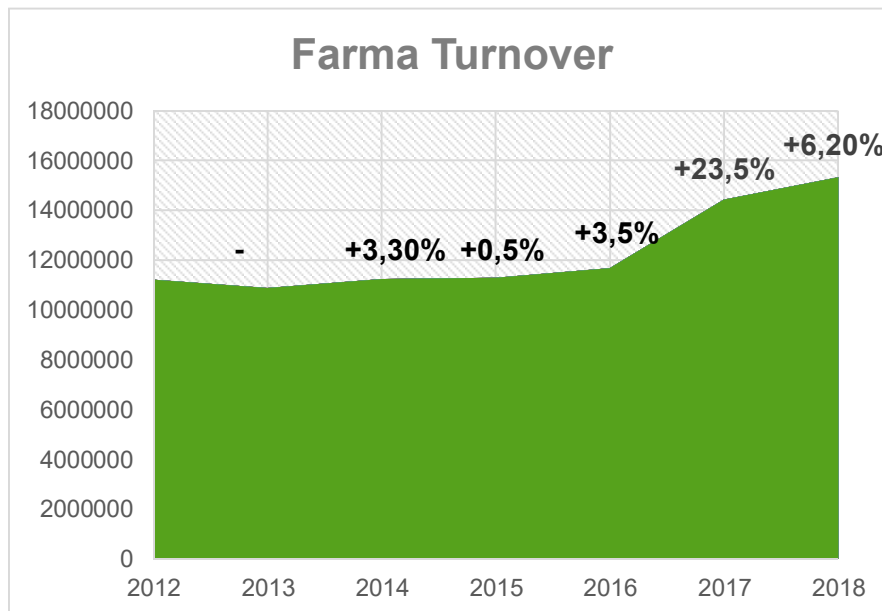

## F.A.R.M.A. - S.R.L. - FABBRICA ACCESSORI RICAMBI MOTO E AUTO

### CREDIT PASSPORT ASSESSMENT

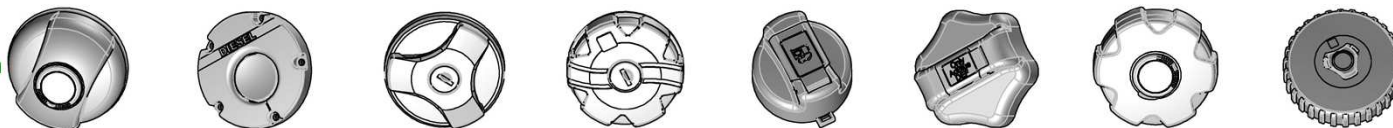

## Our customers

Farma has almost 500 customers located all over the world. Our core business is supplying fuel and urea tank locking sets for tractors, trucks, construction machinery.

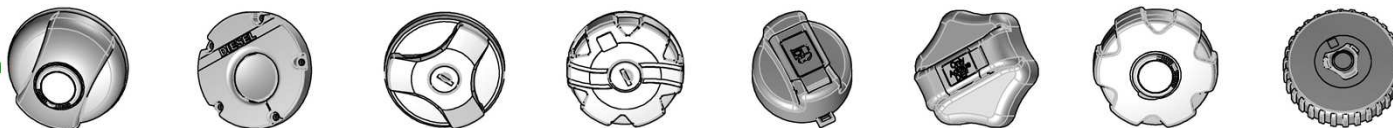
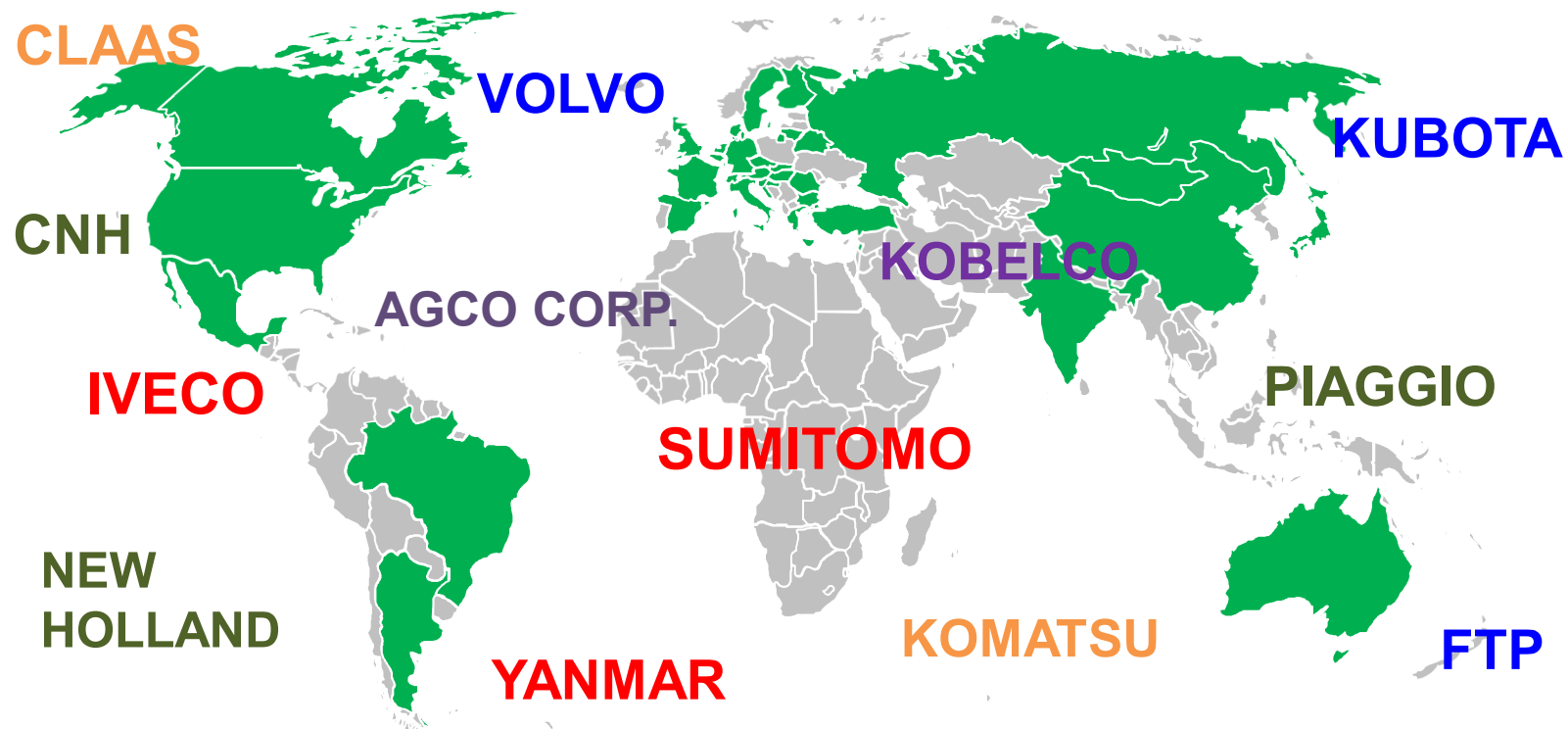

## A choice from our widest range of products

We have a very complete range of caps, filler necks and filters for every kind of plastic or metal tank, for fuel and urea.



Urea filler neck female screw, bayonet connection  $\varnothing 60$ , with 50 micron filter, with neodymium magnet



Locking diesel tank cap, bayonet connection  $\varnothing 60$ , vented with equa valve, with external plastic cord



Female screw  $\varnothing 65 \times 6,5$  filler neck to be welded on metal tank



Urea filler neck to be welded with hot blade, bayonet connection  $\varnothing 40$ , with 40 micron filter, with neodymium magnet



Radiator cap, female screw, vented with venting system, with pipe connection



Double layer stainless steel filter

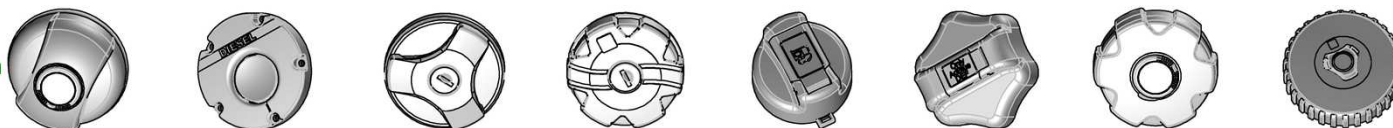

## Quality policy and certifications

Farma is a strategic partner and a reference for rules compliance.



The Company is certified for **ISO 9001**, for **ISO 14001** environmental management system and has the **AIA / IPPC** authorization.

In addition, since 2017 the Company has adopted a **code of ethics**, to ensure its honesty and social responsibility in compliance with the regulations related to safety at work, environment and privacy.



Currently, the Farma Automotive Division is implementing the **IATF 16949:2016 Certification process**.

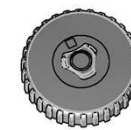

## Quality service: metrologic room

Our metrologic room is equipped with different tools such as:

- CMM automatic mobile portal machine 3d
- CMM manual mobile portal machine 3d
- height gauge
- profile projector

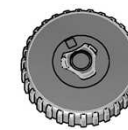
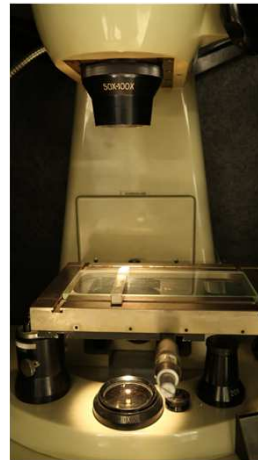

## Quality service: laboratory

The main tools used to test and validate our products are:

- pressure and depressure work station
- urea and fuel pump: to measure the maximum flow rate during tank filling
- salt spray chamber: to test corrosion to atmospheric agents
- controlled humidity chamber: to simulate aging in extreme conditions
- high/low temperature chambers: to simulate aging in extreme conditions
- wearing testing machine: to simulate aging in extreme conditions
- vibration testing machine: to simulate aging in extreme conditions

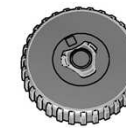

## Technical Office

Farma's Technical Office is able to support the customer in developing the best designed solutions.

It is equipped with **3D prototyping printers** allowing to better clarify the problems related to moulding and mould construction.

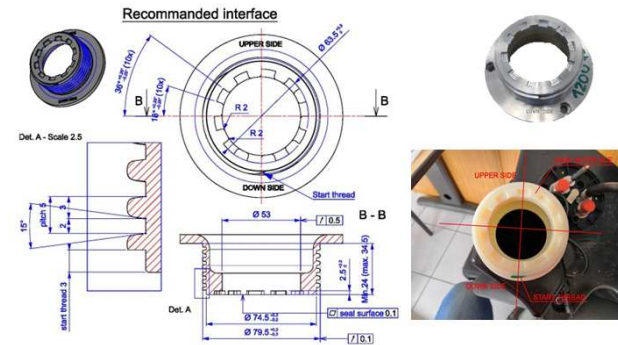

Farma collaborates with the world of **university research** to constantly train and have a support in solving problems.

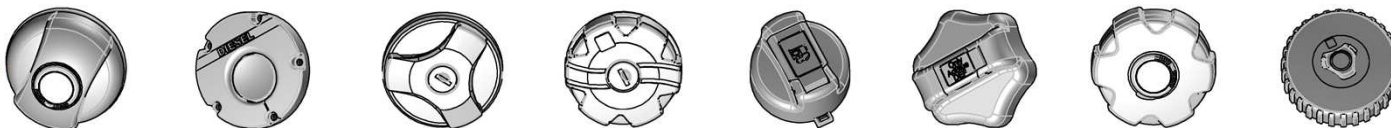

## Production facilities

Our products are assembled by specialized operators with the support of specific tools and processes helping to optimize work and prevent problems. The production department is equipped with a **laser marker** allowing to grant lot traceability and to show item code number. A **100% verification** of the cap seal and valve values is available upon customer's request.



Laser Marker

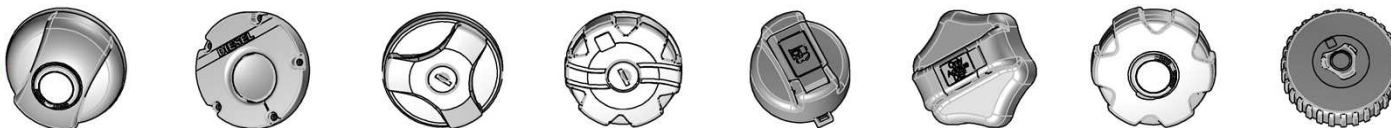



## RECENT PRODUCTS – EQUA VALVE SYSTEM

- Innovative valve system, with pressure spring, vacuum spring and sphere
- The small size of the pressure spring allows tanks ventilation and prevents swelling in the tank of any size
- Allows for homologation of all tank sizes, small, medium, large
- The sphere prevents fuel leakage in case of rollover of the vehicle working in sloping conditions.

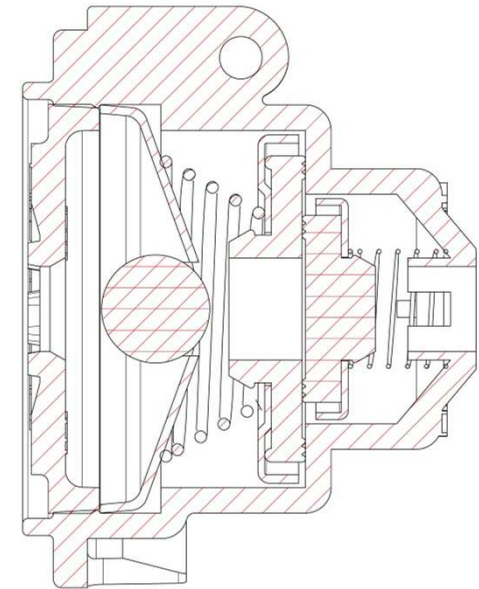

*EQUA sealing check by rollover test H2O column pressure of 3000 mms (taken from EU norm 70/221/CE).*

*Valve pressure test 3000 mmsH2O for 5 min.*

*Maximum leakage observed at 3000 mmsH2O pressure = 15 grs/min.*

*N.B.: Maximum allowed by UN E/ECE/34rev.1 and EU 70/221/CE = 30 grs/min.*

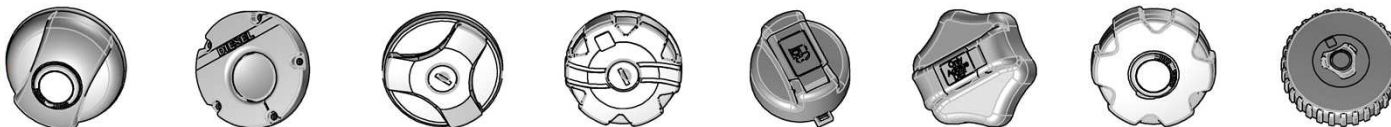

## RECENT PRODUCTS – REMOTE FILLING SYSTEMS

This is a refuelling system where the filler is not located nearby the tank neck.  
 It is supplied with a flexible hose, with or without filter.  
 Suitable for Urea and Fuel Tank.  
 Suitable with orientable pipe to improve tank ventilation



**PATENT PENDING**

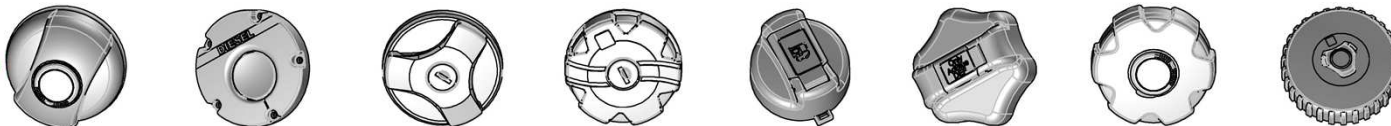
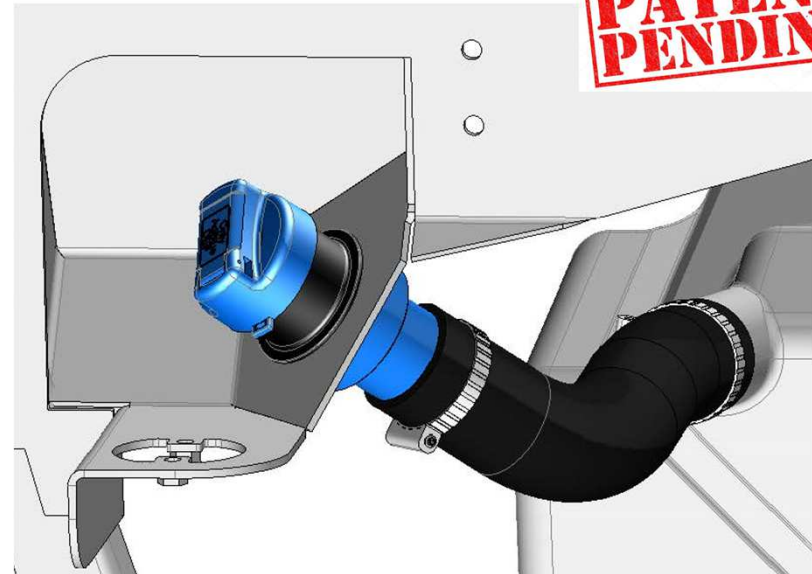

## RECENT PRODUCTS – STAINLESS STEEL 40 MICRON FILTER

New filler neck female screw for bayonet 40mms caps with strainer with neodimium magnet and 40 micron web. This special shape of strainer allows a flow rate of 40 liters/minute.

This filter can be mounted on all Farma plastic filler necks and complies with mostly severe request of filtration from main pump device manufacturer.



**PATENT PENDING**

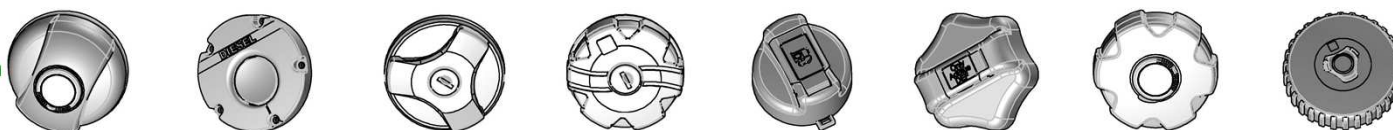

## COMING SOON – ø80 FEMALE SCREW KIT

New filler neck female screw for bayonet 80mms caps.

New locking tank cap, bayonet model, made with plastic ring with equa valve.

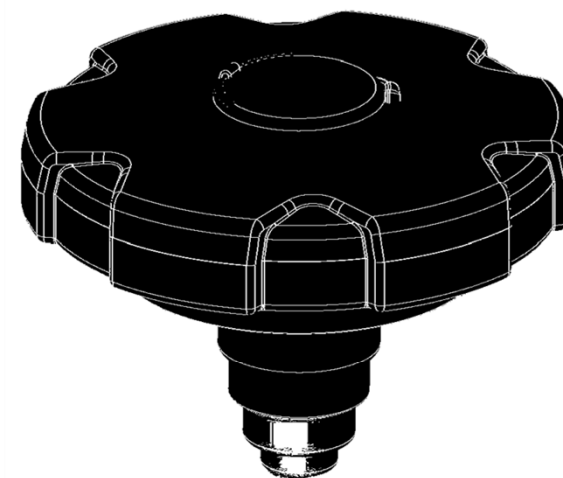
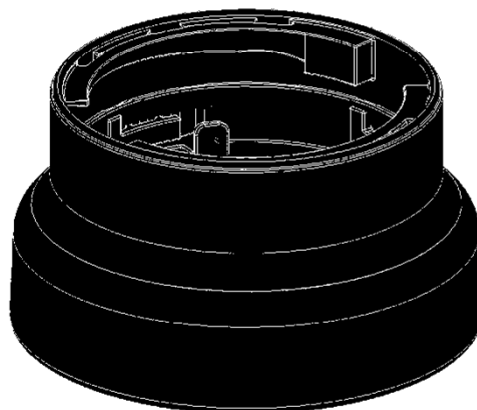
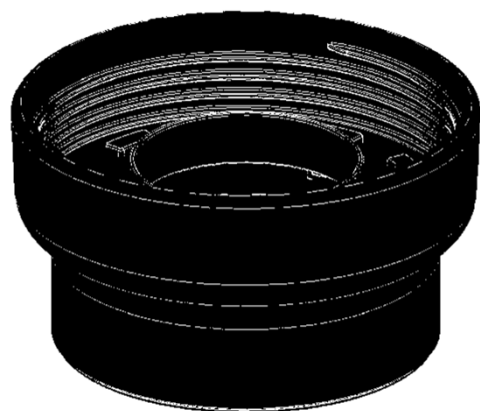

## Contact us and ask for a quotation

You can address your enquiry by sending the following information to the below mentioned address:

- Product specification
- EAU

**E-mail address:**

[farma@farmagroup.it](mailto:farma@farmagroup.it)

The whole or partial reproduction of the contents of this publication is allowed only under direct written authorization of the

F.A.R.M.A. S.R.L.

Description and pictures on this presentation are merely indicative. FARMA Co. reserve the right to change at all times construction and technical features of their models.

Copyright.© 2019 Farma. All right reserved

*July 2019*

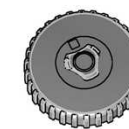



**Come and visit us,  
 we look forward to you!**

